

机加工滚针轴承

d 10-50mm-NA4908-RSRNA4908-2RSR

参数信息:

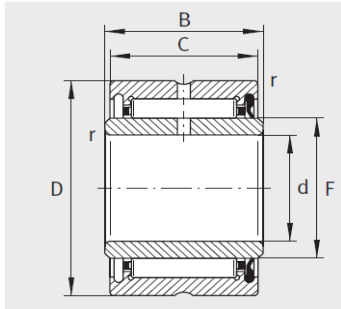

NA4908-RSR

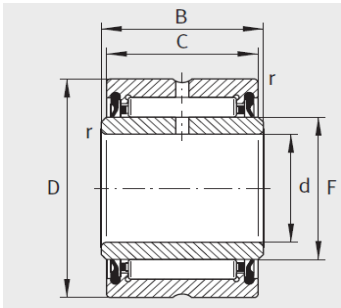

NA4908-2RSR

型号1 :	NA4908-RS R
型号2 :	NA4908-2RS R
X-life :	XL
质量 g :	252

尺寸mm :

d :	40
F :	48
D :	62
C :	22
B :	23
r min :	0.6
静载荷 :	41000
动载荷 :	53000
疲劳极限载荷/N :	8800
极限转速 :	4200

: